









LMT78_0.5R1 series

Wide input, non-isolated & regulated, single output, SMD package

Switching Regulator

-  10PIN SMD package
-  UL94V-0 package material
-  Operating temperature: -40°C to +85°C
-  Efficiency up to 89%
-  Non isolated
-  No need for heatsinks
-  Short circuit protection

The Introducing our advanced LMT78_0.5R series with a 10PIN SMD package, engineered for superior performance and reliability. Constructed with UL94V-0 package material, it ensures high safety standards and flame retardancy. This package operates efficiently within a temperature range of -40°C to +85°C, making it suitable for various environmental conditions. With an impressive efficiency of up to 89%, this non-isolated package delivers optimal energy utilization without the need for additional heatsinks. Its design includes built-in short circuit protection, providing an extra layer of safety and durability for your applications.



Common specifications	
Cooling:	Free air convection @(20 LFM)
Short circuit protection mode:	Hiccup mode
Short circuit protection:	Continuous, automatic recovery
Operating temperature range:	-40°C ~ +85°C (with derating)
Storage temperature range:	-55°C ~ +125°C
Conducted Emission Radiated Emission	EN55022 Class A EN55022 Class A
Reflow Soldering Temperature:	Peak temp. ≤ 245°C, maximum duration time ≤ 60s at 217°C. For actual application, please refer to IPC/JEDEC J-STD-020D.1
Storage humidity range:	95% (max.)
Case material:	Plastic [UL94-V0]
MTBF (MIL-HDBK-217F, +25°C):	> 5000 x 103 hours (ground Benign)
Package weight:	1.8g
Dimensions:	15.24 x 8.00 x 8.50mm
MSL (Moisture sensitivity level):	J-STD-020D standard - Level 1

Output specifications					
Item	Test conditions	Min	Typ	Max	Units
Output voltage accuracy	3.3V			±4	%
	5V			±3	%
	12V			±3	%
Output current	500mA				
Line regulation	@ at Full Load			±0.4	%
Load regulation	@10% to 100% load			±0.6	%
Ripple + Noise*	20MHz bandwidth			75	mVp-p
Output Voltage Adjustability (Trim)				±10	%
Transient response deviation	Nominal input voltage, 25% load step change		50	200	mV
Transient recovery time	Nominal input voltage, 25% load step change		0.2	1	ms
Vadj	input voltage range		±10		%Vo
Switching frequency			400		kHz

* Ripple and noise tested with "parallel cable" method, please refer to DC-DC converter Application Notes for specific operation methods.

Example:

LMT78_05-0.5R1

LM = Series; T = SMT case; 05 = 5Vout; 0.5 = 0.5A; R1 = Revised series

Note:

1. All specifications measured at Ta = 25°C, humidity <75%, nominal input voltage and rated output load unless otherwise specified.
2. In this datasheet, all the test methods of indications are based on corporate standards.

Input specifications					
Item	Test conditions	Min	Typ	Max	Units
No load input current			3		mA
Reverse polarity input	Forbidden				
Input filter	Capacitor				
Remote ON	3.2 ~ 5.5VDC or open circuit				
Remote OFF	0 ~ 0.8VDC or short circuit pin 10 and 3/7				
OFF Idle Current	0.2mA typ.				

LMT78_0.5R1 series

Wide input, non-isolated & regulated, single output, SMD package

EMC specifications

EMI	CE	CISPR32/EN55022	CLASS B	(see EMC recommended circuit, ②)
EMI	RE	CISPR32/EN55022	CLASS B	(see EMC recommended circuit, ②)
EMS	ESD	IEC/EN61000-4-2	Contact ±4KV	perf. Criteria B
EMS	RS	IEC/EN61000-4-3	10V/m	perf. Criteria A
EMS	EFT	IEC/EN61000-4-4	±2kV	perf. Criteria B (see EMC recommended circuit, ①)
EMS	Surge	IEC/EN61000-4-5	line to line ±1KV	perf. Criteria B (see EMC recommended circuit, ①)
EMS	CS	IEC/EN61000-4-6	3 Vr.m.s	perf. Criteria A

Product Selection Guide

Part Number	Input Voltage [VDC]		Output Voltage [VDC]	Output Current [mA, Max]	Capacitive load [μF, max]	Efficiency [Vin. max]
	Nominal	Range				
LMT78_03-0.5R	24	4.75-36	3.3	500	680	89
LMT78_05-0.5R	24	6.5-36	5	500	680	93
LMT78_09-0.5R	24	12-36	9	500	680	90
LMT78_15-0.5R	24	18-36	15	500	680	93
LMT78_12-0.5R	24	15-36	12	500	680	94

Note: For input voltage higher than 30VDC, a 22μF/50V input capacitor is required.

Typical characteristics

Temperature derating graph

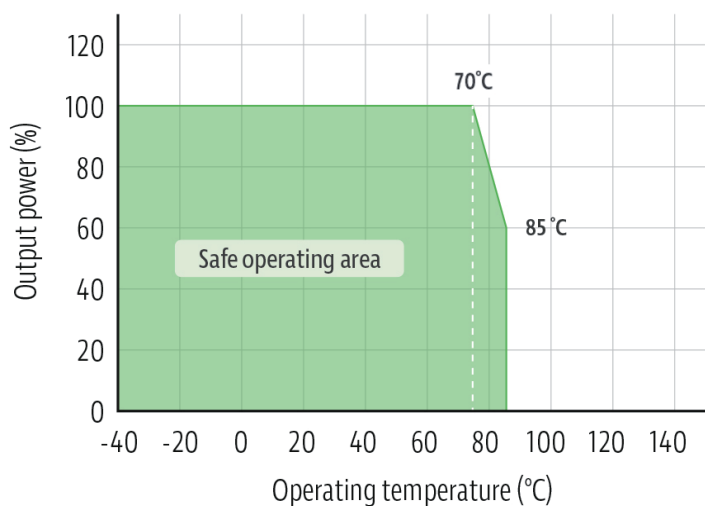

LMT78_0.5R1 series

Wide input, non-isolated & regulated, single output, SMD package

Application of Vadj and calculation of Vadj resistance

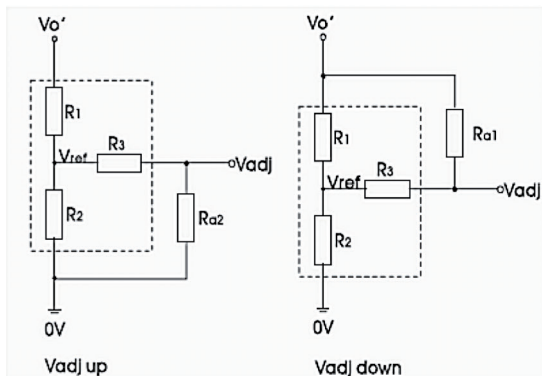

Calculation formula of Vadj resistance:

$$\text{up: } R_{a2} = \frac{\alpha R_2}{R_2 - \alpha} - R_3 \quad \alpha = \frac{V_{ref}}{V_{o'} - V_{ref}} R_1$$

$$\text{down: } R_{a1} = \frac{\alpha R_1}{R_1 - \alpha} - R_3 \quad \alpha = \frac{V_{o'} - V_{ref}}{V_{ref}} R_2$$

Ra1, Ra2 is Vadj resistance, a is a self-defined parameter, with no real meaning. Vo' for the actual needs of the up or down regulated voltage

R1/KΩ	R2/KΩ	R3/KΩ	Vref/V
75	24	33	0.8

Typical application circuit

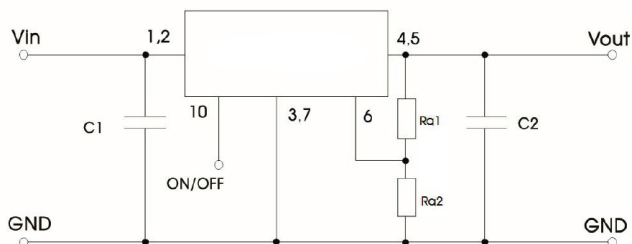

Note:

- C1 and C2 are required and should be connected close to the pin terminal of the module.
- The capacitance of C1 and C2 refer to table 1, it can be increased properly if required, and tantalum or low ESR electrolytic capacitors may also suffice.
- Cannot be used in parallel for output and hot swap. To reduce the output ripple furtherly, it is suggested to connect a "LC" filter at the output terminal, and recommended value of L is 10μH-47μH.

Part number Vin (24VDC)	C1	Single Vout	C2
LMT78_03-0.5R1	10μF/50V	3.3VDC	22μF/16V
LMT78_05-0.5R1	10μF/50V	5VDC	22μF/16V
LMT78_12-0.5R1	10μF/50V	12VDC	22μF/25V

Table 1

EMC (CLASS B) compliance circuit

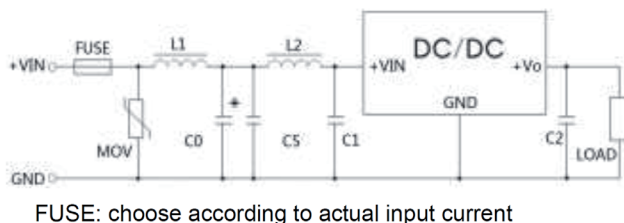

FUSE: choose according to actual input current

Component	Value	Component	Value
MOV	S20K30	C0	680μF/50V
L1	82μH	C1,C2	refer to Fig.1
L2	68μH	C5	4.7μF/50V

Fig. 2

LMT78_0.5R1 series

Wide input, non-isolated & regulated, single output, SMD package

Mechanical dimensions

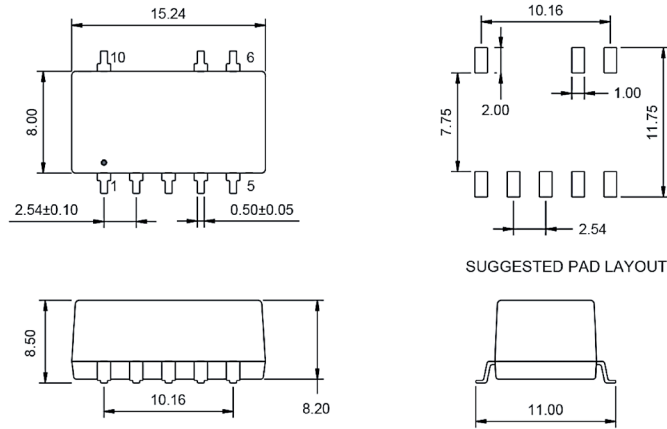

PIN Assignment

PIN	1.2	3.7	4.5	6	10
FUNCTION	+Vin	GND	+Vout	V adj	Remote On/Off

Note:

Unit: mm[inch]

Pin selection tolerances: $\pm 0.10\text{mm}$ [$\pm 0.004\text{inch}$]

General tolerances: $\pm 0.25\text{mm}$ [$\pm 0.010\text{inch}$]

IR Reflow peak temperature: 240degC +/-5degC

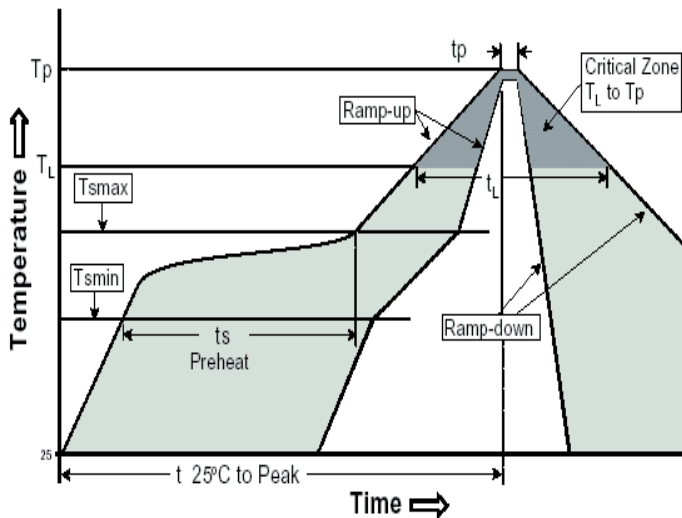

Profile Feature	Pb-Free Assembly
Average Ramp-Up Rate (Ts max to Tp)	3°C/second max.
Preheat	
-Temperature Min (Ts min)	150°C
-Temperature Max (Ts max)	200°C
-Time (ts min to ts max)	60-180 seconds
Time maintained above:	
-Temperature (Tl)	217°C
-Time (tl)	60-150 seconds
Peak/Classification Temperature (Tp)	240±5°C
Time within 5°C of actual Peak Temperature (tp)	20-40 seconds
Ramp-Down Rate	6°C/seconds max
Time 25°C to Peak Temperature	6 minutes max.