



FEATURES

- 2.5V~5.5V Power supply.
- Thermal shutdown Protection.
- Low current shutdown mode.
- No capacitors and networks or bootstrap capacitors required.
- Low noise during turn-on and turn-off transitions.
- User selectable stereo headphone function.
- Lead free and green package available. (RoHS Compliant)
- Space Saving Package
 - 16-pin QFN (3*3*0.75 mm) Package

APPLICATION

- Portable electronic devices
- Portable and desktop computers
- Cell Phones
- Multimedia Monitors
- Audio System

PIN CONFIGURATION

GENERAL DESCRIPTION

The LY8662 is a dual bridge-connected audio power amplifier. It is capable of driving 4Ω speaker load at a continuous average output of 2.0W / 10% distortion (THD+N) from a 5.5V power supply. It primarily designed for high quality application in other portable communication device and portable and desktop computers device.

The audio amplifier features low power consumption in shutdown mode. And it has an internal thermal shutdown protection feature.

LY8662 audio amplifier was designed specifically to provide high quality output power with a minimal amount of external components. The LY8662 does not require output capacitors, and it is ideally suited for other low voltage applications or portable electronic devices where minimal power consumption is a primary requirement.

16 Pin QFN Package (Top View)

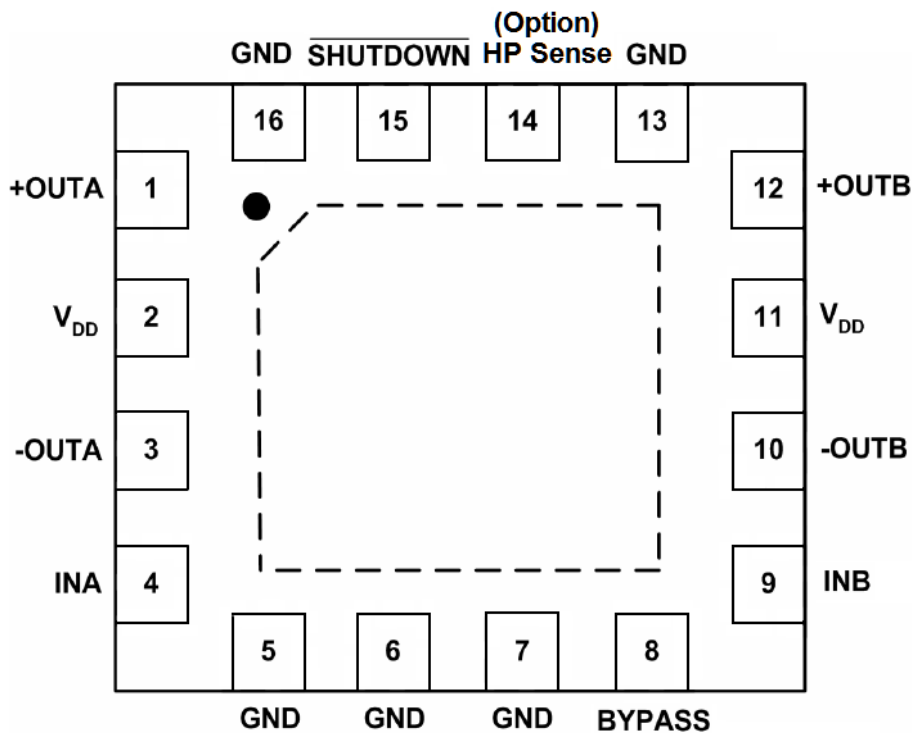



PIN DESCRIPTION

SYMBOL	Pin No.	DESCRIPTION
	QFN	
+OUTA	1	Positive BTL output of A channel.
V _{DD}	2/11	Power supply.
-OUTA	3	Negative BTL output of A channel.
INA	4	Input of A channel.
GND	5/6/7/13/16	Ground.
BYPASS	8	Bypass capacitor which provides the common mode voltage.
INB	9	Input of B channel.
-OUTB	10	Negative BTL output of B channel.
+OUTB	12	Positive BTL output of B channel.
HP Sense (Option)	14	Headphone sense pin option. <i>(If None headphone function must connect to GND).</i>
SHUTDOWN	15	Shutdown the device pin.(when low level is active the pin)

APPLICATION CIRCUIT

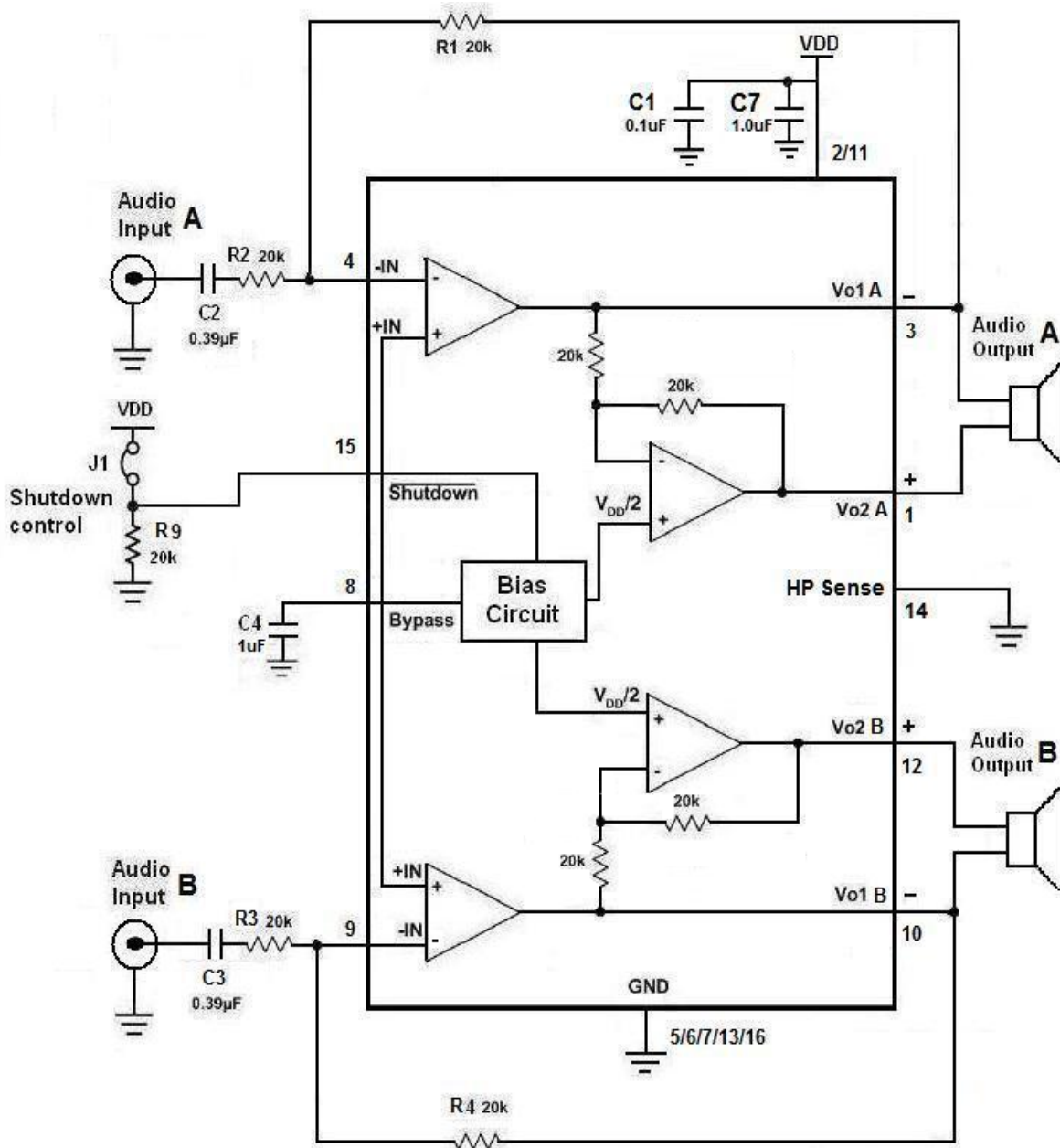

Figure 1. Without Headphone Typical Application Circuit (QFN16)

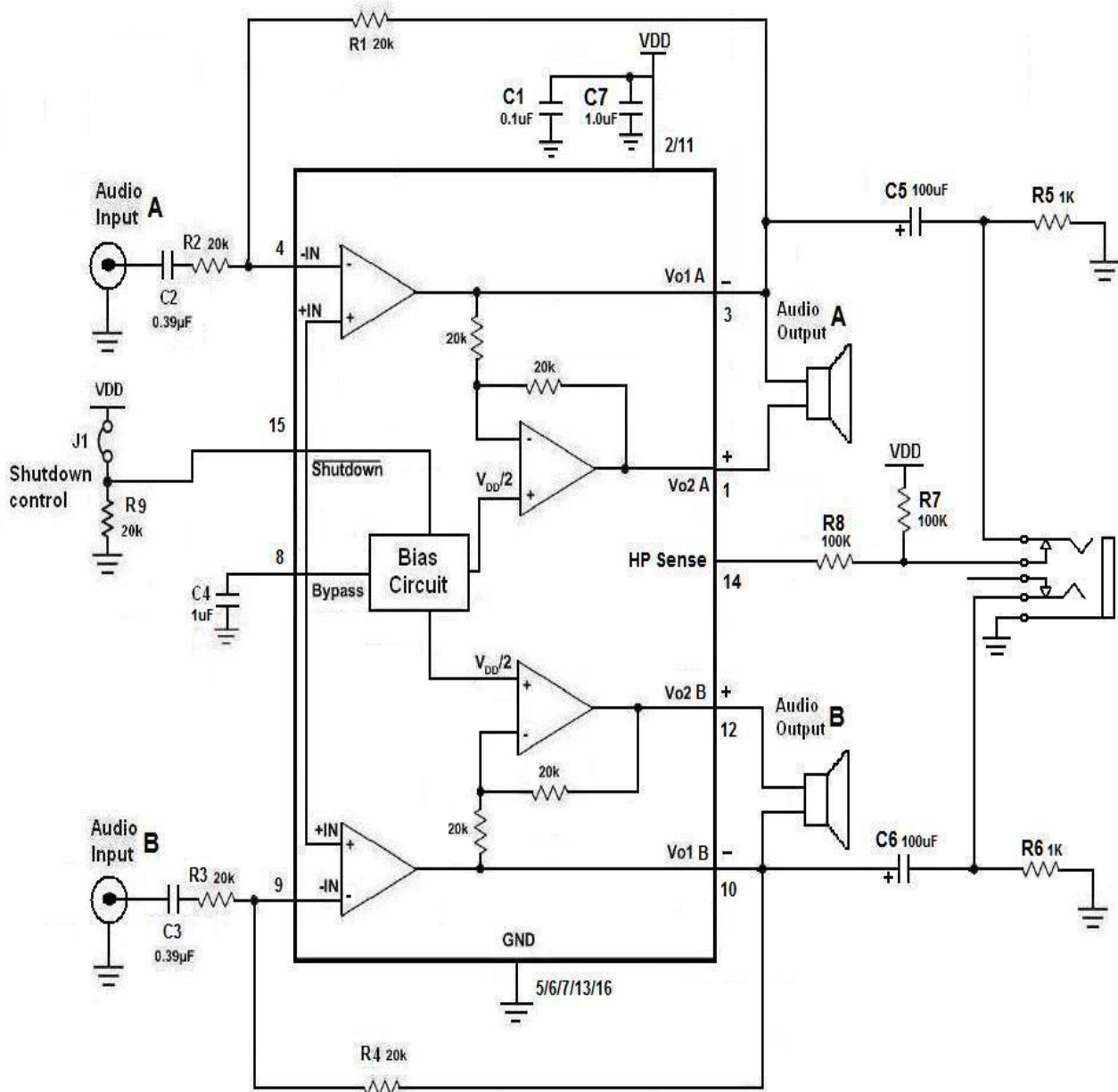
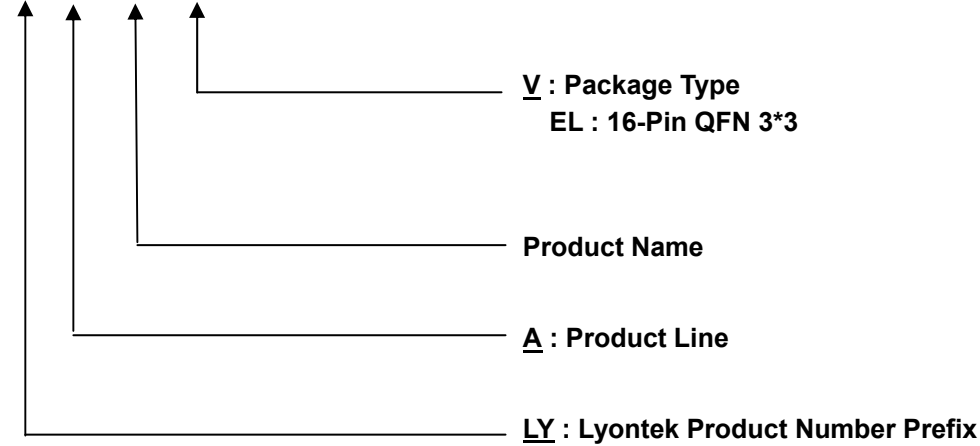

Figure 2. With Headphone Typical Application Circuit (QFN16)



ORDERING INFORMATION

LY 8 662 VV



ABSOLUTE MAXIMUM RATINGS*

PARAMETER	SYMBOL	RATING	UNIT
Supply Voltage	V _{DD}	6.0	V
Operating Temperature	T _A	-40 to 85 (I grade)	°C
Input Voltage	V _I	-0.3V to V _{DD} +0.3V	V
Storage Temperature	T _{STG}	-65 to 150	°C
Power Dissipation	P _D	Internally Limited	W
ESD Susceptibility	V _{ESD}	2000	V
Junction Temperature	T _{JMAX}	150	°C
Soldering Information	Vapor Phase (60 sec.)	215	°C
	Infrared (15 sec.)	220	



DC ELECTRICAL CHARACTERISTICS (V_{DD}=5.0V, T_A=25°C)

PARAMETER	SYMBOL	TEST CONDITION	MIN.	TYP.	MAX.	UNIT
Power Supply Current	I _{DD}	V _{IN} = 0V, 8Ω Load (BTL)	-	12.0	21.5	mA
Shutdown Current	I _{SD}	V _{SHUTDOWN} = 0V, HP sense= GND	-	0.1	1.0	μA
Shutdown, Headphone Sense High Input Voltage	V _{SDIH}		1.4	-	-	V
Shutdown, Headphone Sense Low Input Voltage	V _{SDIL}		-	-	0.4	V
Wake-up time	T _{WU}	Bypass cap.=1.0uF	-	172	-	ms
Output Offset Voltage	V _{OS}		-	7.0	50.0	mV
Output Power	P _O	THD+N = 1%, f = 1 kHz, R _L =8Ω	-	1.1	-	W
		THD+N = 10%, f = 1 kHz R _L =8Ω	-	1.4	-	
		THD+N = 1%, f = 1 kHz R _L =4Ω	-	1.4	-	
		THD+N = 10%, f = 1 kHz R _L =4Ω	-	1.8	-	
		THD+N = 10%, f = 1 kHz R _L =4Ω (at 5.5V)	-	2.0	-	
		THD+N = 0.1%, f = 1 kHz, R _L =32Ω (SE Mode)	-	90	-	mW
		THD+N = 0.1%, f = 1 kHz, R _L =16Ω (SE Mode)	-	165	-	
Total Harmonic Distortion+ Noise	THD+N	P _O = 0.4 W _{rms} ; f = 1kHz, R _L =8Ω	-	0.11		%
Power Supply Rejection Ratio	PSRR	V _{ripple} = 200mV sine p-p. Input terminated with floating.	-	62 (f = 217Hz) 66 (f = 1kHz)	-	dB
Output voltage noise	V _n	f = 20 Hz to 20 kHz, A-weighting	-	37.5	-	μV
		f = 20 Hz to 20 kHz, A-weighting (SE mode)	-	15	-	
Thermal Shutdown Temperature	T _{SD}		150	170	190	°C
Shut Down Time	T _{SdT}	8 Ω load	-	1.0	-	ms



DC ELECTRICAL CHARACTERISTICS (V_{DD}=3.6V, T_A=25°C)

PARAMETER	SYMBOL	TEST CONDITION	MIN.	TYP.	MAX.	UNIT
Power Supply Current	I _{DD}	V _{IN} = 0V, I _o = 0A, 8Ω Load (BTL)	-	10.0	16.5	mA
Shutdown Current	I _{SD}	V _{SHUTDOWN} = 0V HP sense= GND	-	0.1	2.0	μA
Shutdown, Headphone Sense High Input Voltage	V _{SDIH}		1.4	-	-	V
Shutdown, Headphone Sense Low Input Voltage	V _{SDIL}		-	-	0.4	V
Wake-up time	T _{WU}	Bypass cap.=1.0uF	-	82	-	ms
Output Offset Voltage	V _{OS}		-	7.0	50	mV
Output Power	P _o	THD+N = 1%, f = 1 kHz, R _L =8Ω	-	0.5	-	W
		THD+N = 10%, f = 1 kHz R _L =8Ω	-	0.65	-	
		THD+N = 1%, f = 1 kHz R _L =4Ω	-	0.65	-	
		THD+N = 10%, f = 1 kHz R _L =4Ω	-	0.8	-	
		THD+N = 0.1%, f = 1 kHz, R _L =32Ω (SE Mode)	-	45	-	mW
		THD+N = 0.1%, f = 1 kHz, R _L =16Ω (SE Mode)	-	83	-	
Total Harmonic Distortion+ Noise	THD+N	P _o = 0.2 Wrms; f = 1kHz, R _L =8Ω	-	0.12	-	%
Power Supply Rejection Ratio	PSRR	V _{ripple} = 200mV sine p-p. Input terminated with floating.	-	56 (f = 217Hz) 62 (f = 1kHz)	-	dB
Output voltage noise	V _n	f = 20 Hz to 20 kHz, A-weighting	-	37.5	-	μV
		f = 20 Hz to 20 kHz, A-weighting (SE mode)	-	15	-	
Thermal Shutdown Temperature	T _{SD}		150	170	190	°C
Shut Down Time	T _{SdT}	8 Ω load	-	1.0	-	ms



TYPICAL PERFORMANCE CHARACTERISTICS

Figure 3
Total Harmonic Distortion + Noise vs Frequency (RL=8Ω)

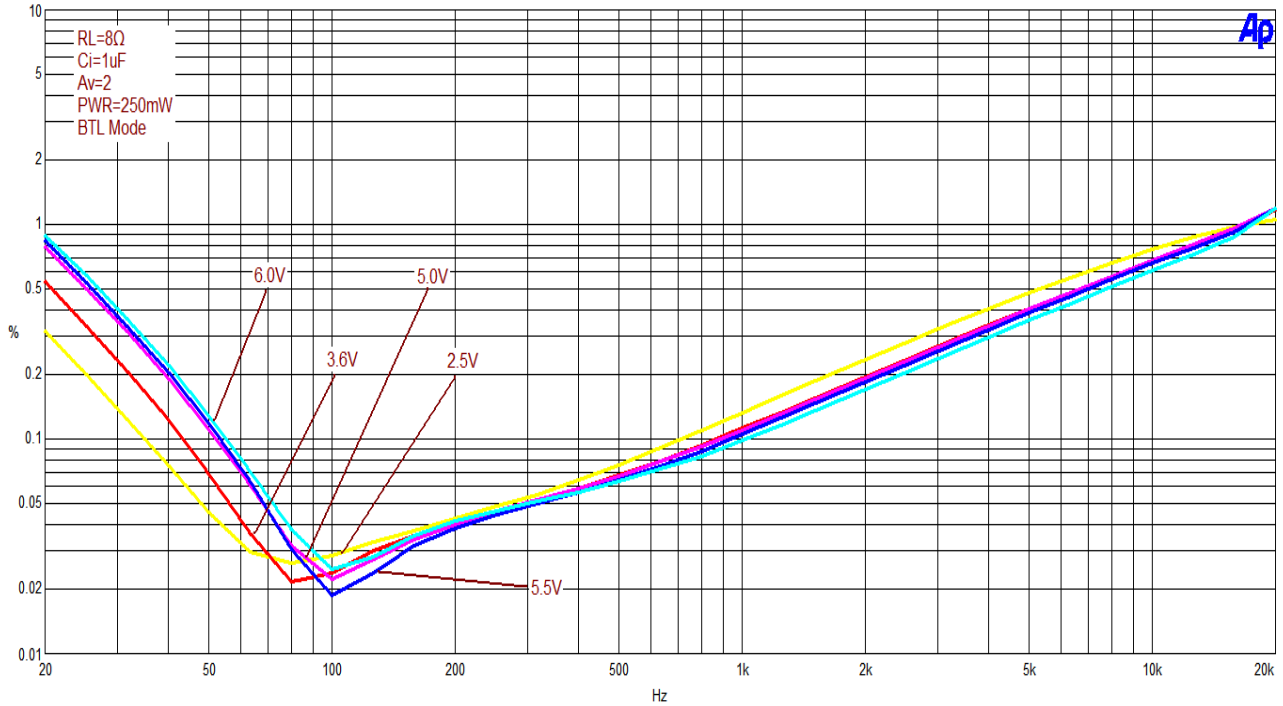

Figure 4
Total Harmonic Distortion + Noise vs Frequency (RL=4Ω)

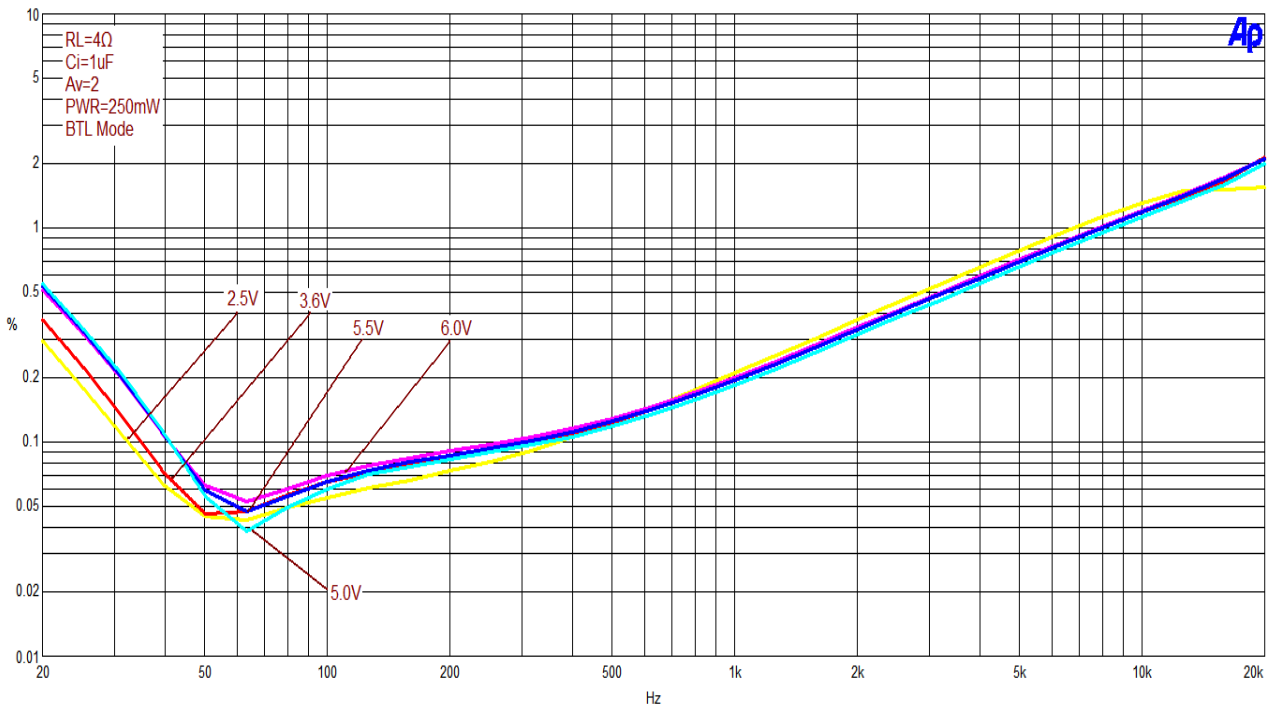



Figure 5
Total Harmonic Distortion + Noise vs Frequency (RL=32Ω)

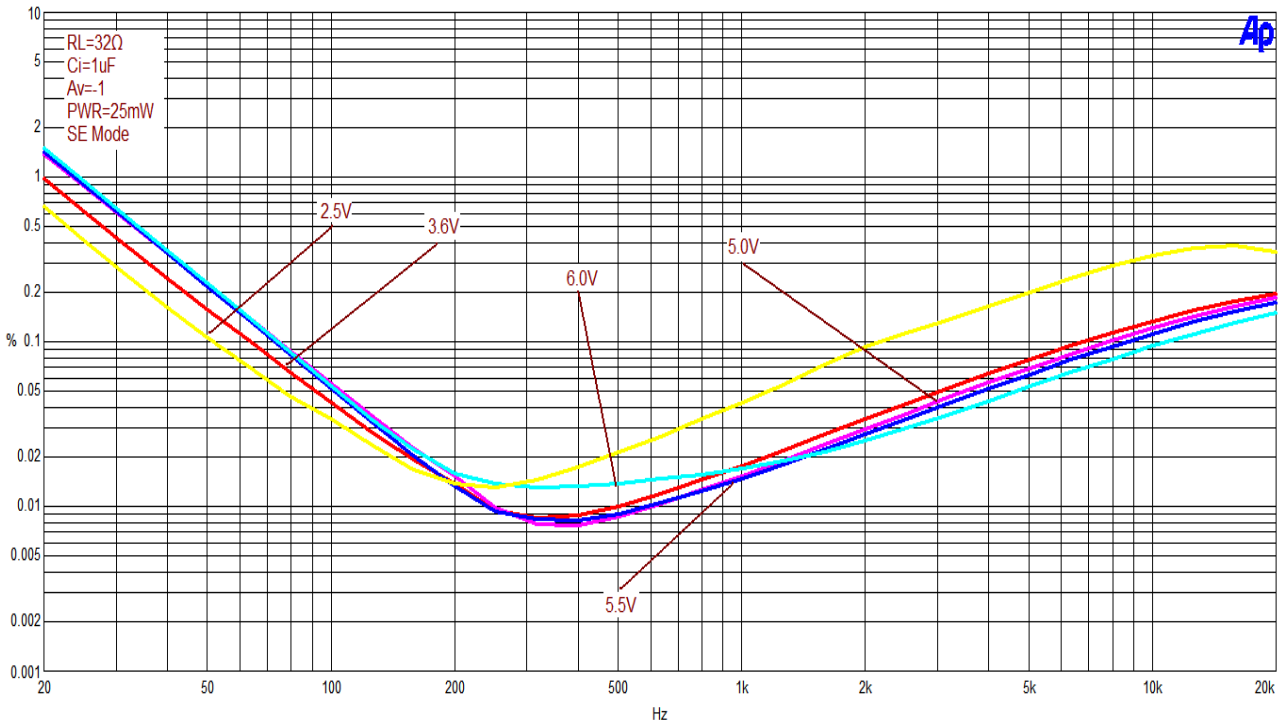

Figure 6
Total Harmonic Distortion + Noise vs Frequency (RL=16Ω)

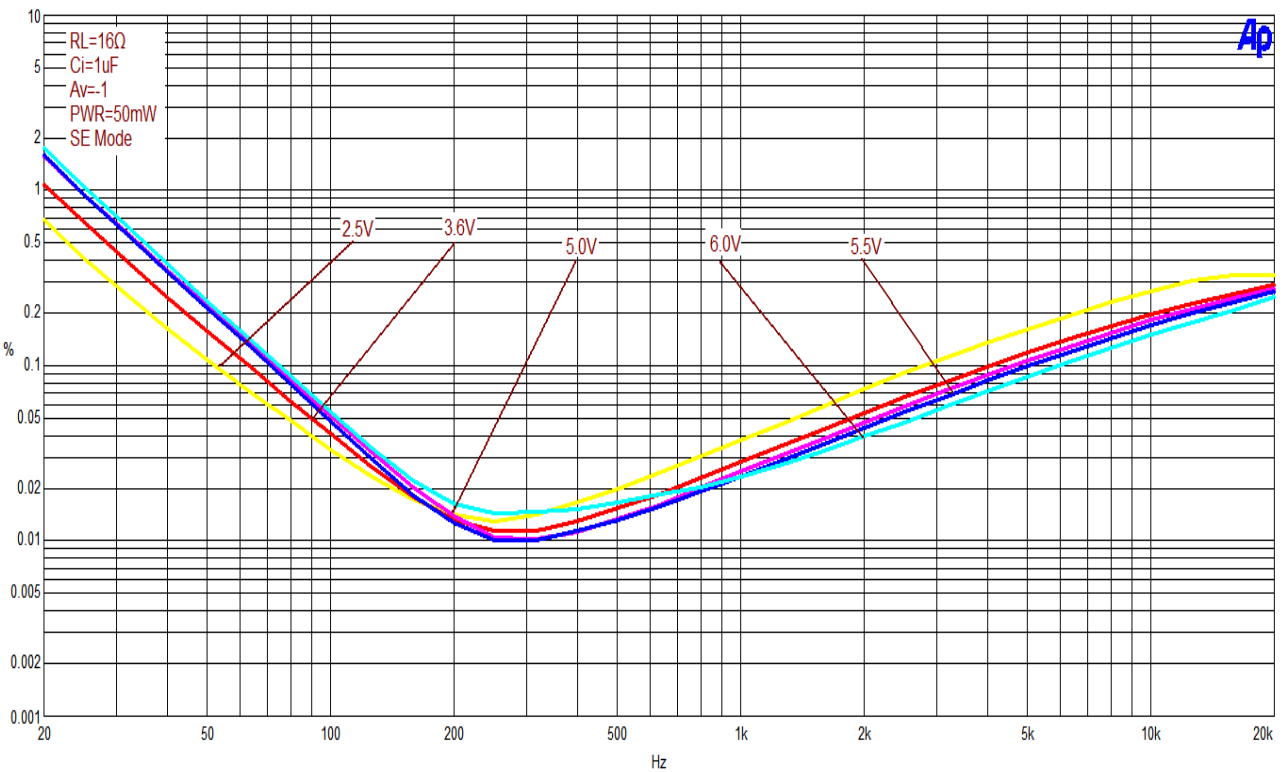



Figure 7
Total Harmonic Distortion + Noise vs Frequency (RL=8Ω)

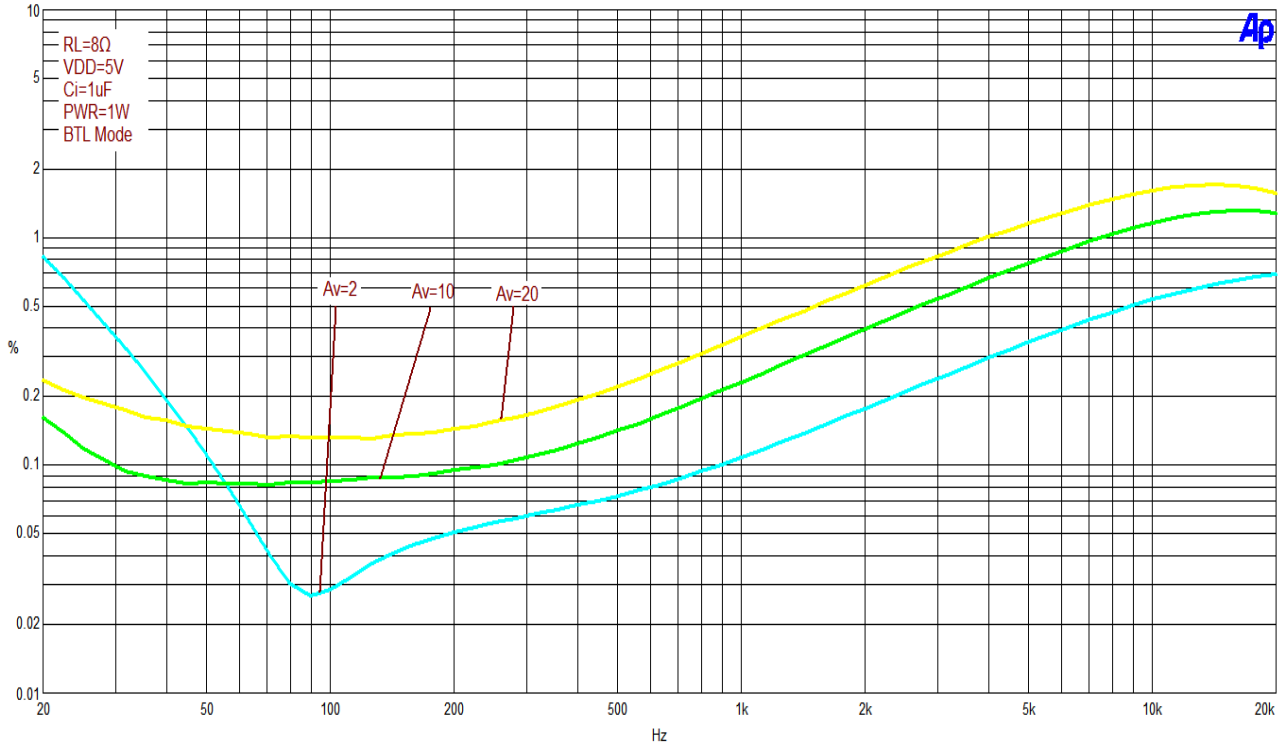

Figure 8
Total Harmonic Distortion + Noise vs Frequency (RL=4Ω)

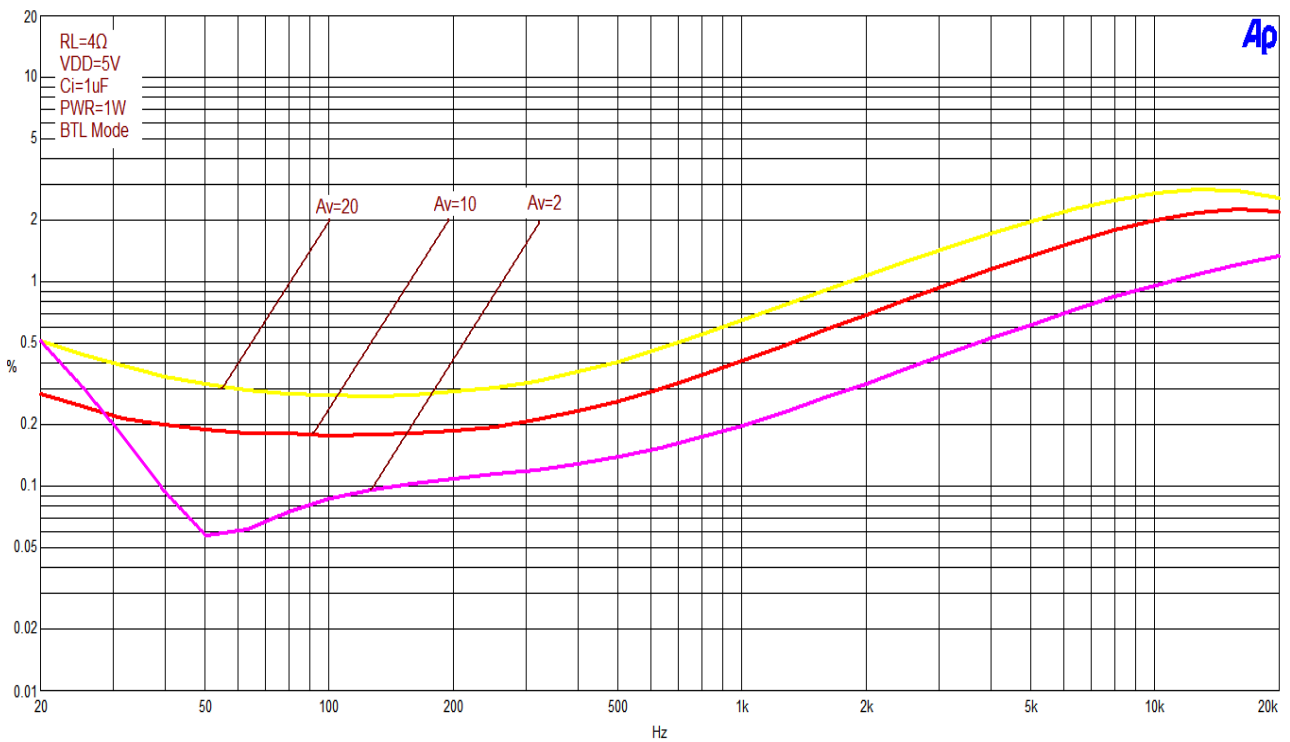



Figure 9
Total Harmonic Distortion + Noise vs Output Power (RL=8Ω)

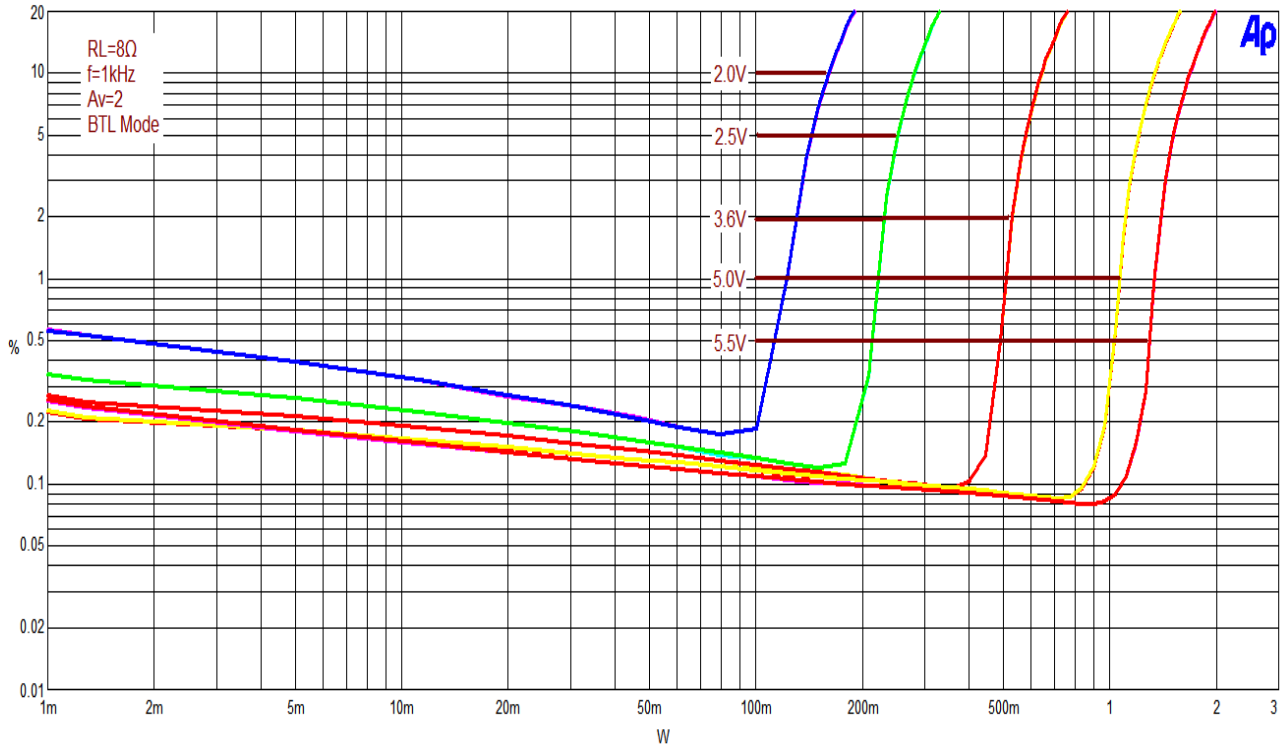

Figure 10
Total Harmonic Distortion + Noise vs Output Power (RL=4Ω)

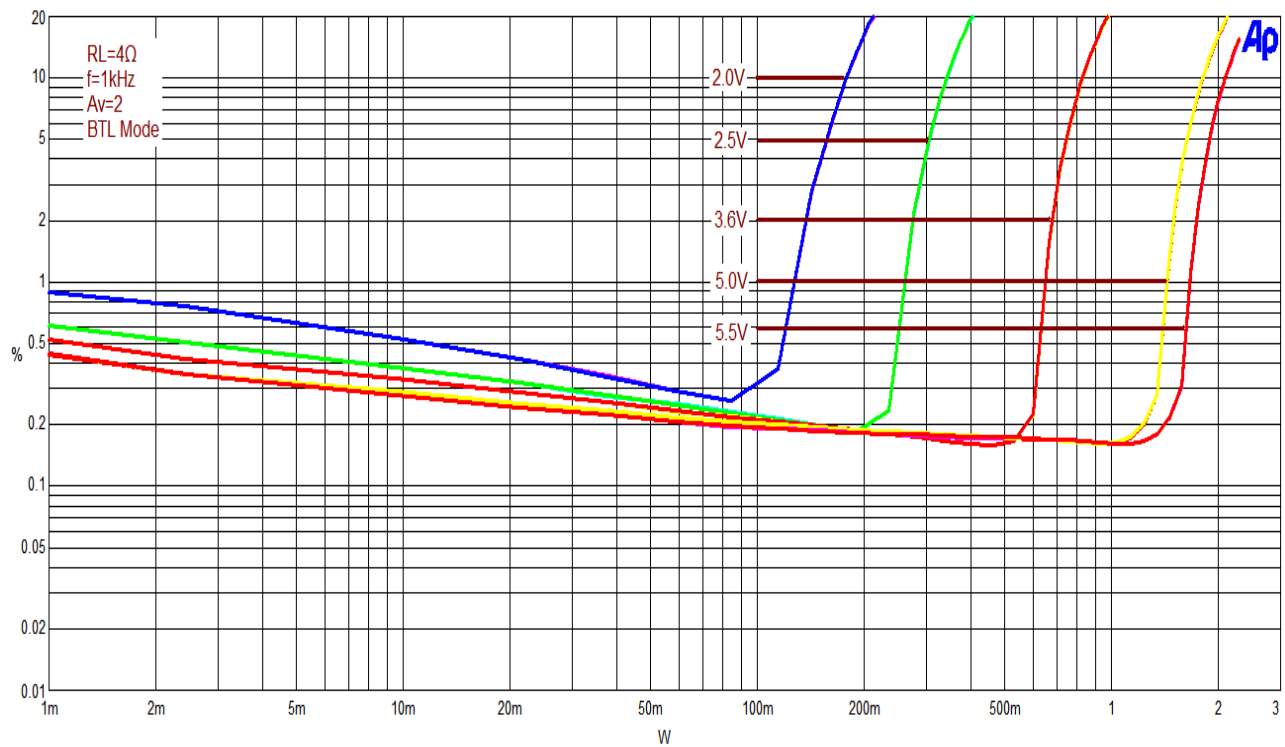



Figure 11
Total Harmonic Distortion + Noise vs Output Power (RL=32Ω)

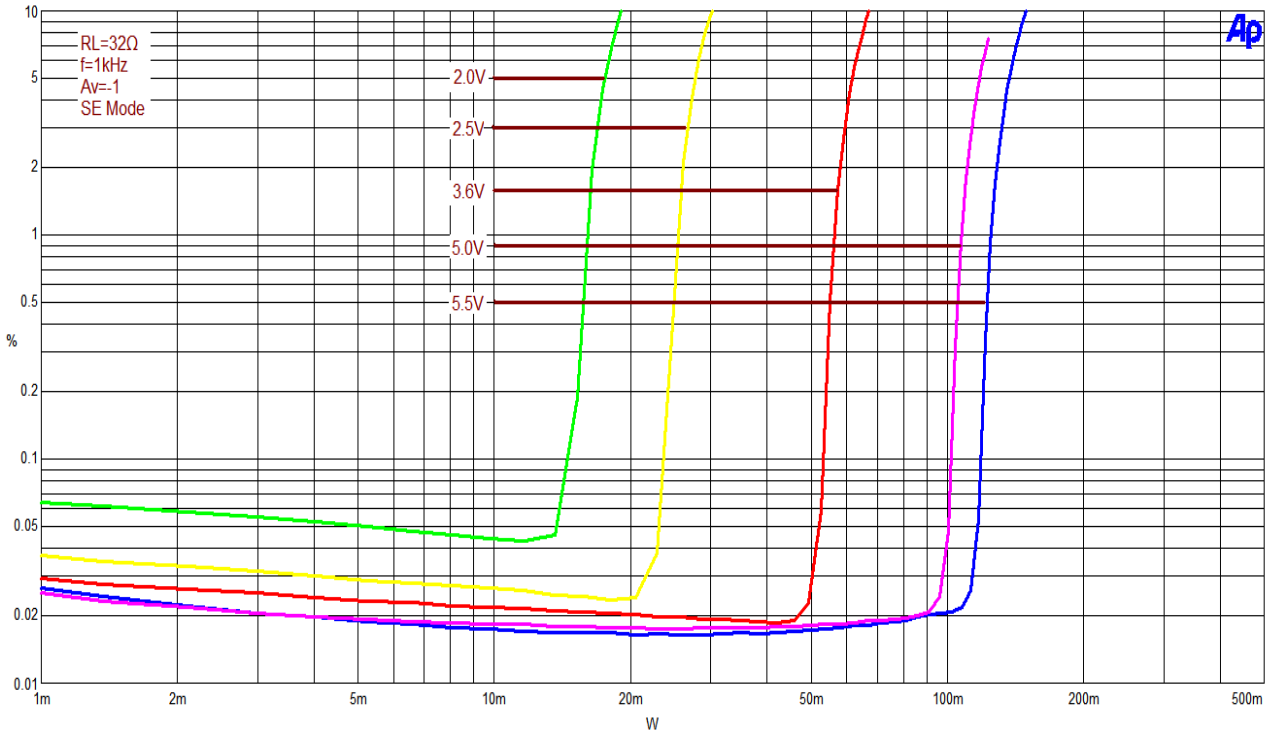

Figure 12
Total Harmonic Distortion + Noise vs Output Power (RL=16Ω)

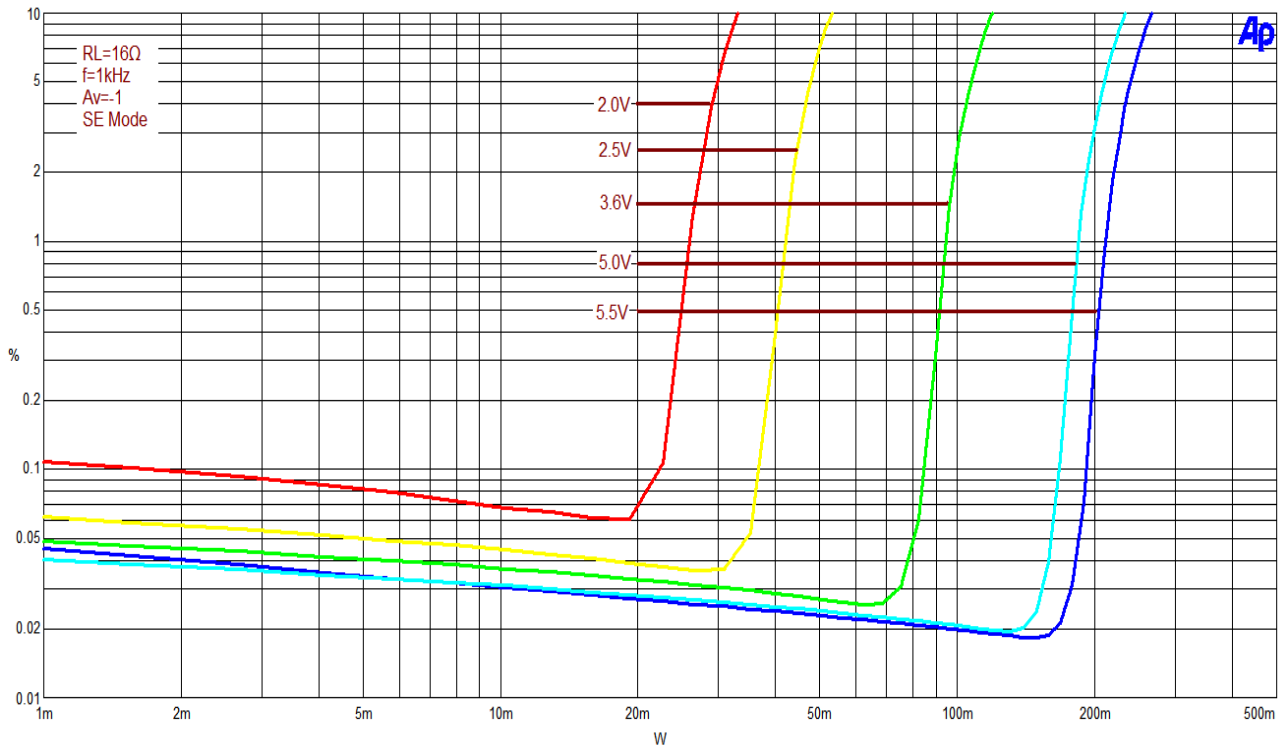



Figure 13
Frequency Response (RL=8Ω / 4Ω)

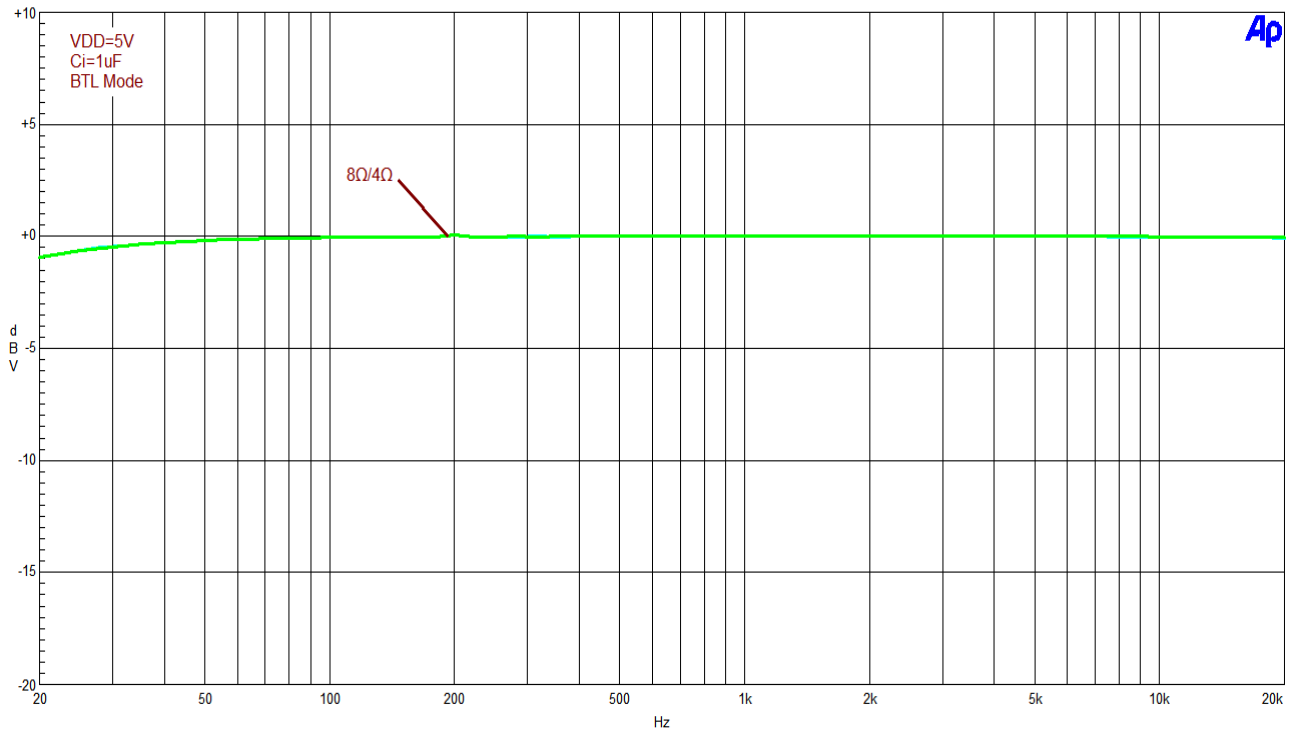

Figure 14
Frequency Response (RL=32Ω / 16Ω)

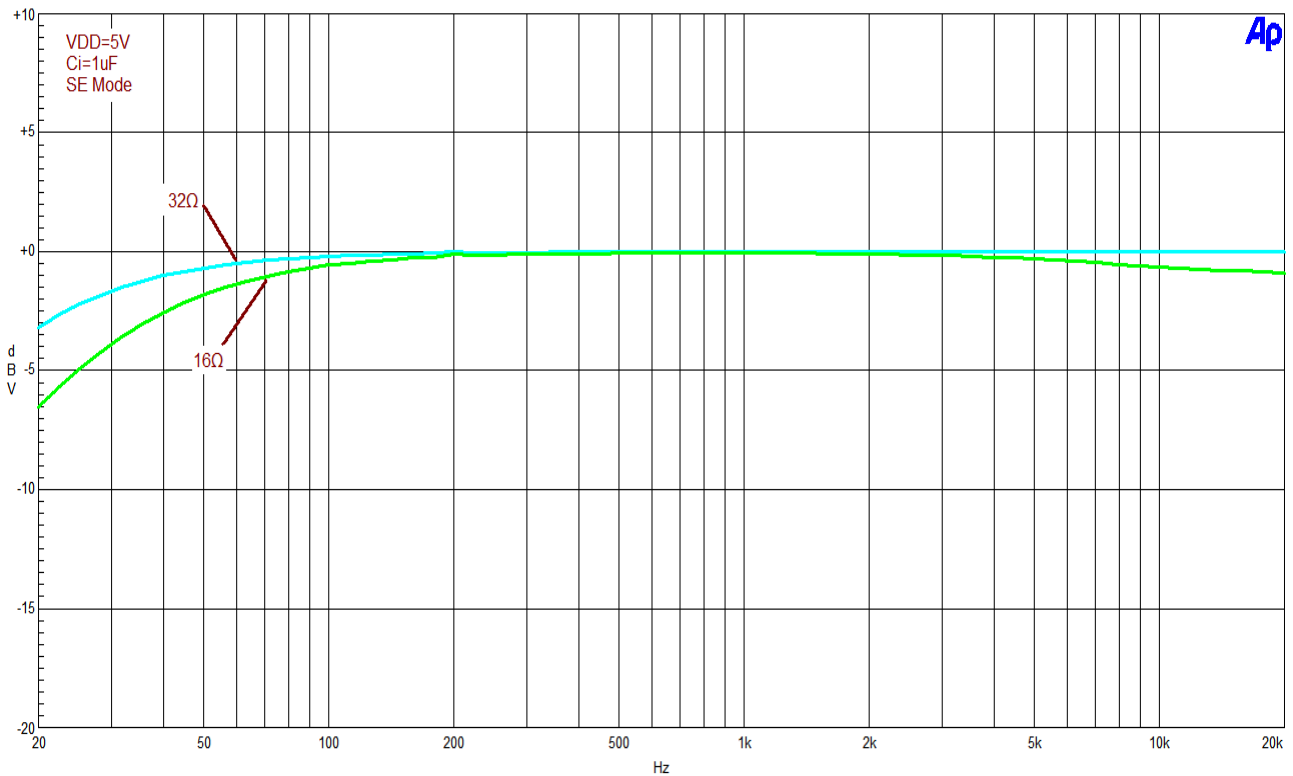



Figure 15
Crosstalk (RL=8Ω)

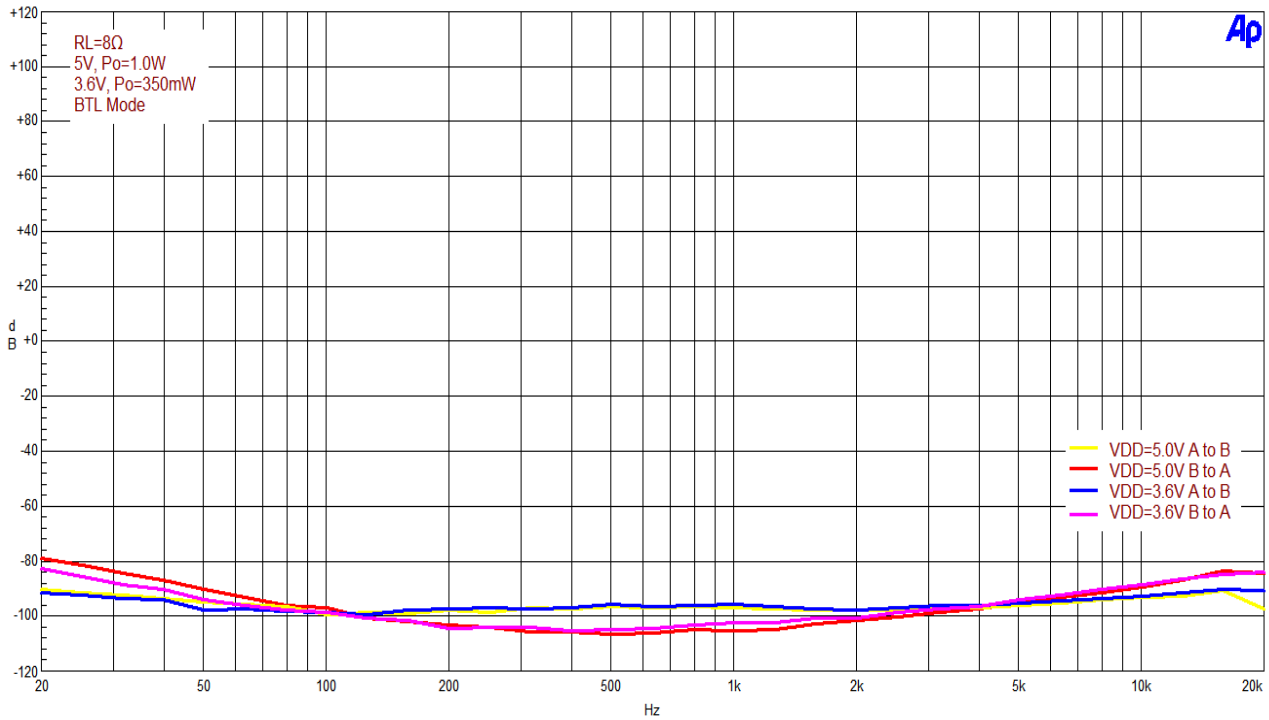

Figure 16
Crosstalk (RL=4Ω)

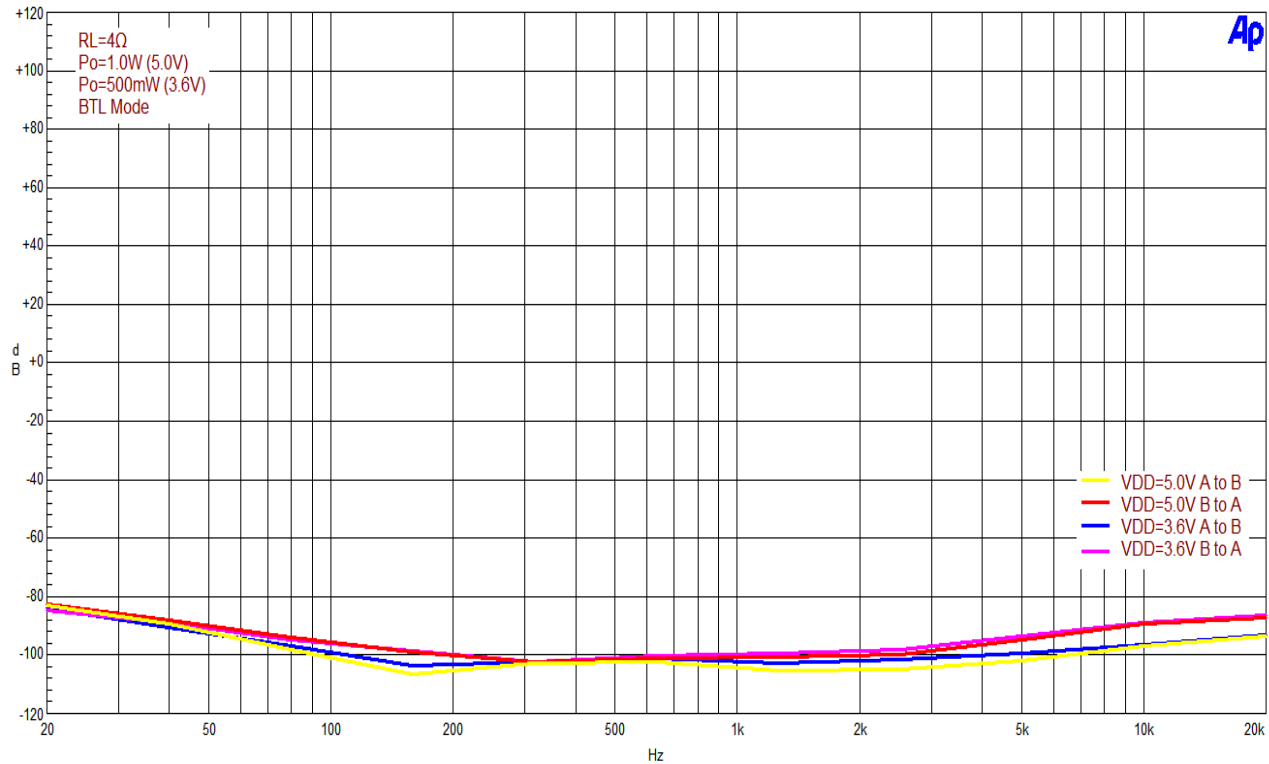



Figure 17
Crosstalk (RL=32Ω)

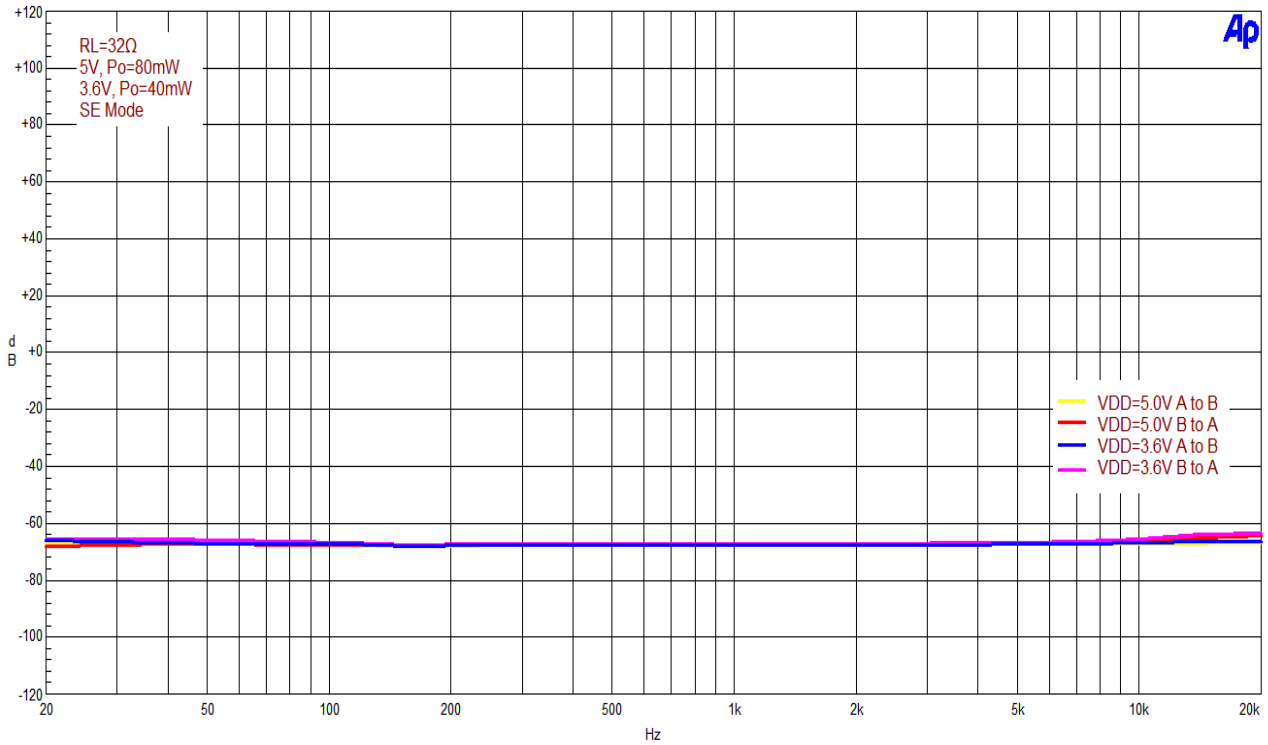

Figure 18
Crosstalk (RL=16Ω)

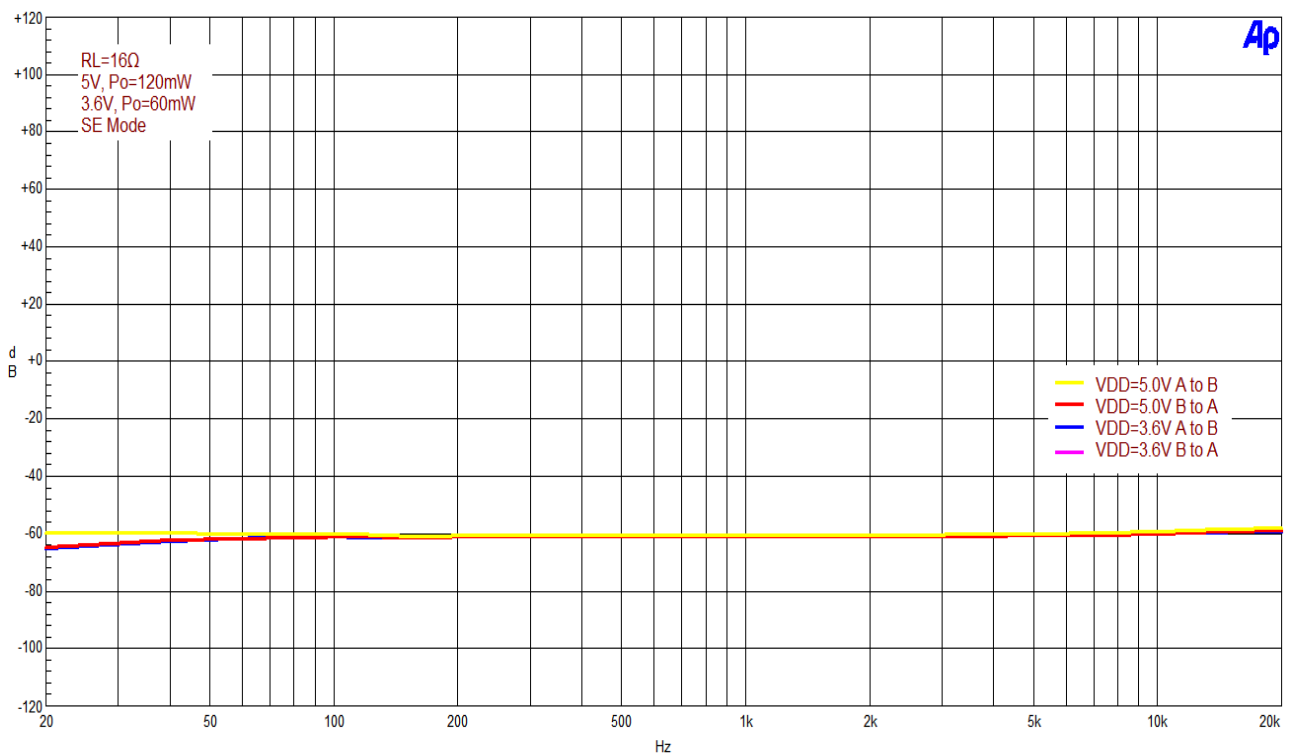



Figure 19
Power Supply Rejection Ratio (8Ω)

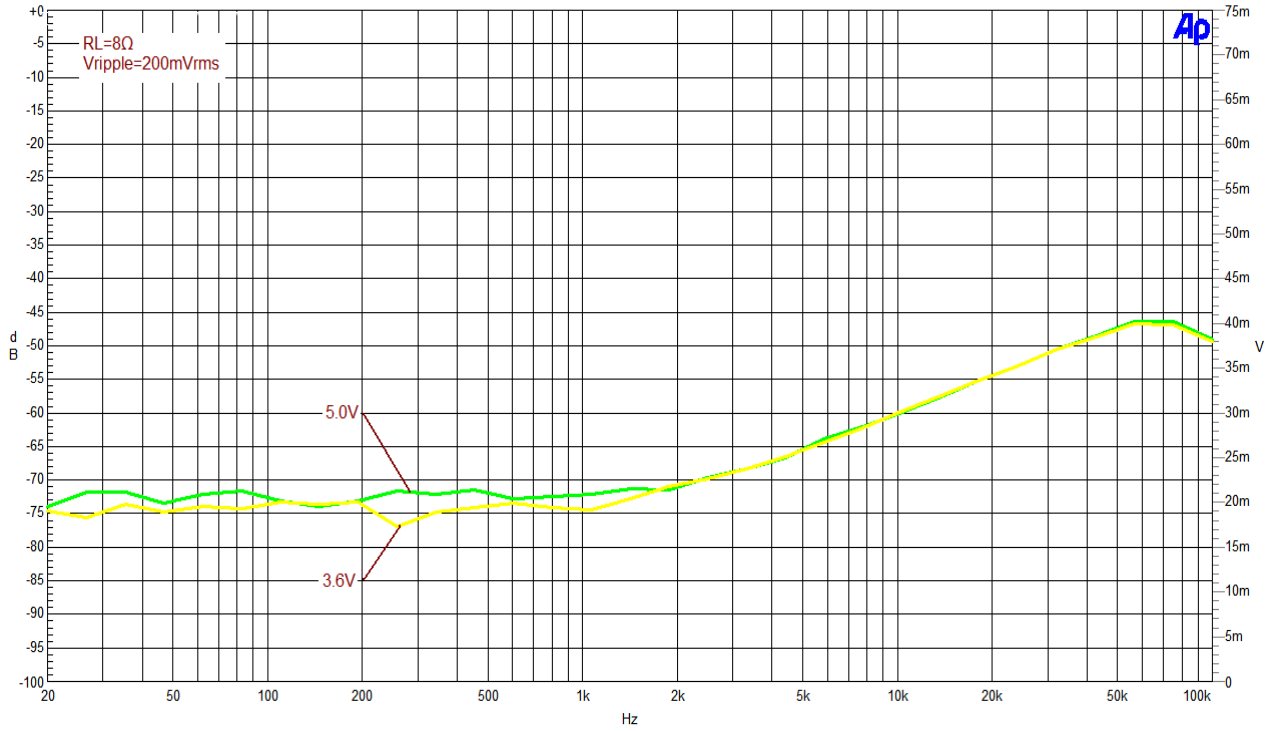

Figure 20
Power Supply Rejection Ratio (4Ω)

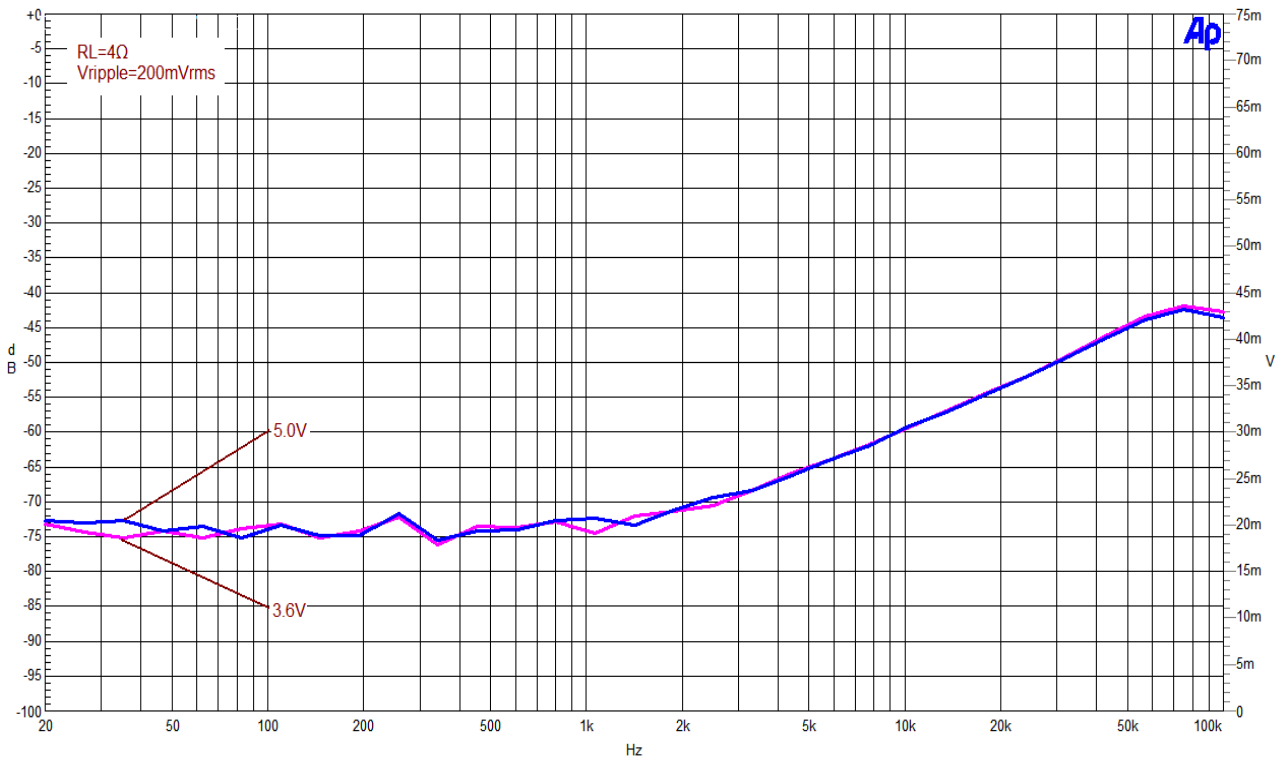



Figure 21
Noise Floor (VDD=5.0V / 8Ω)

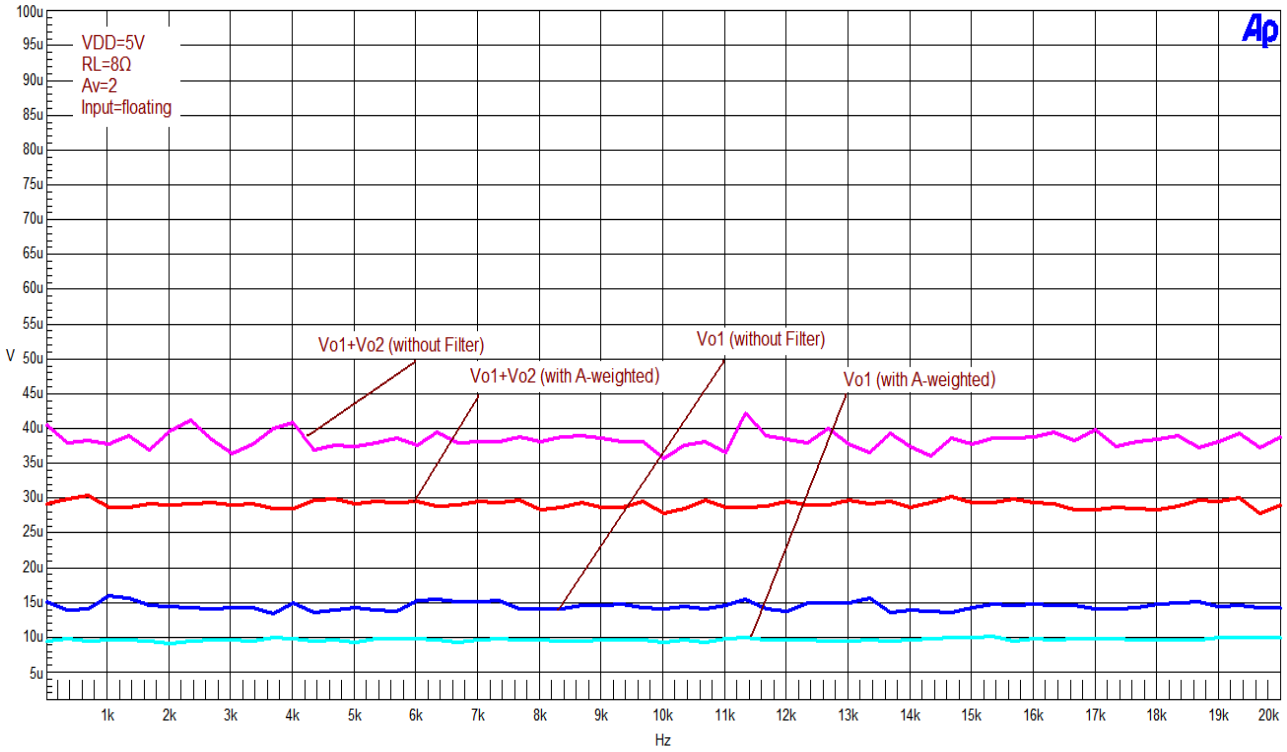
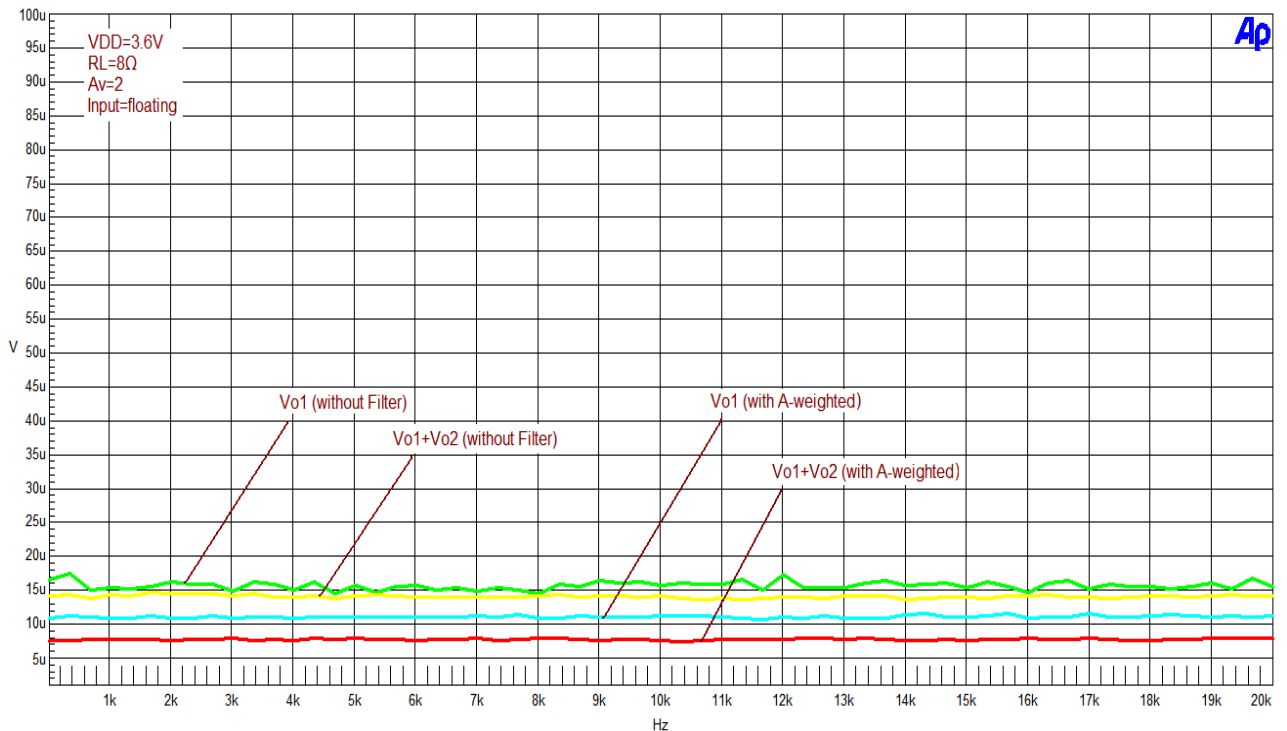
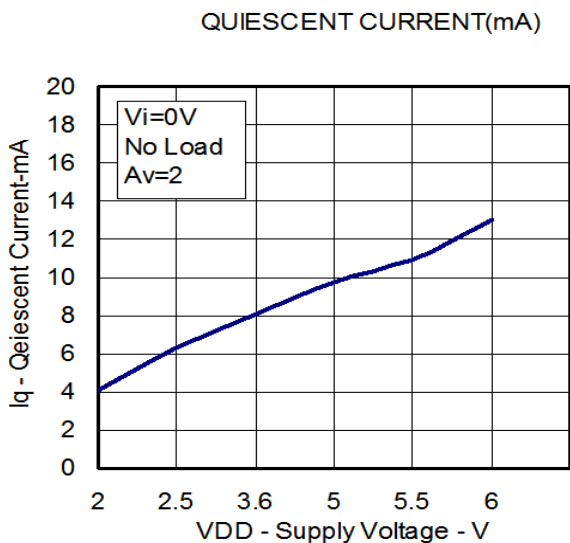
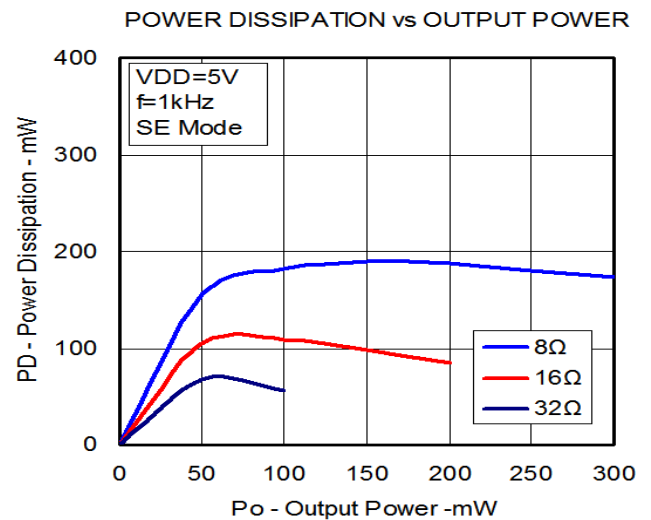
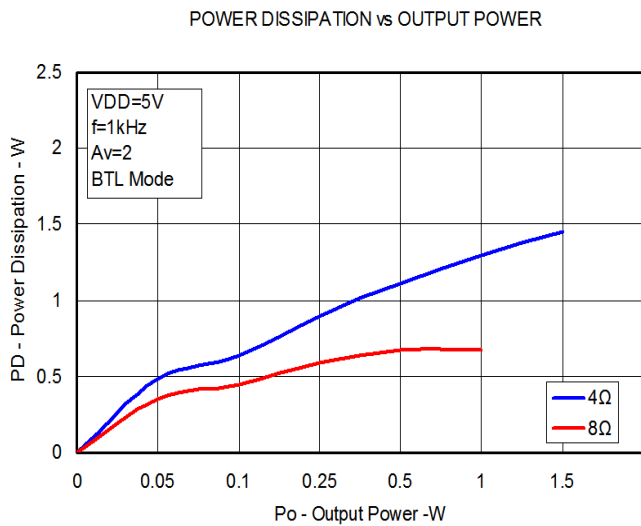
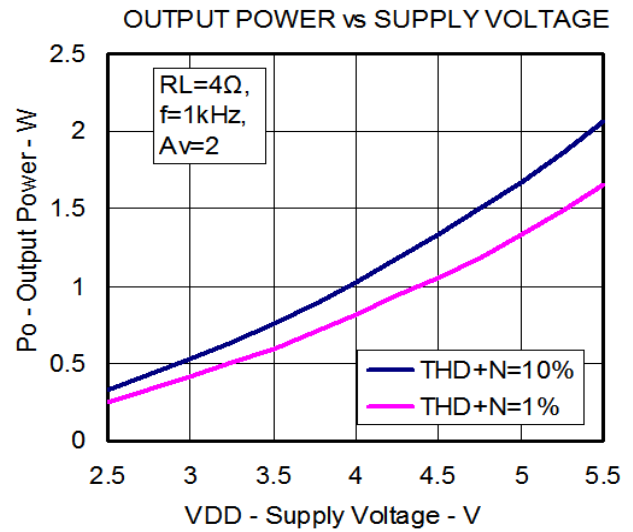
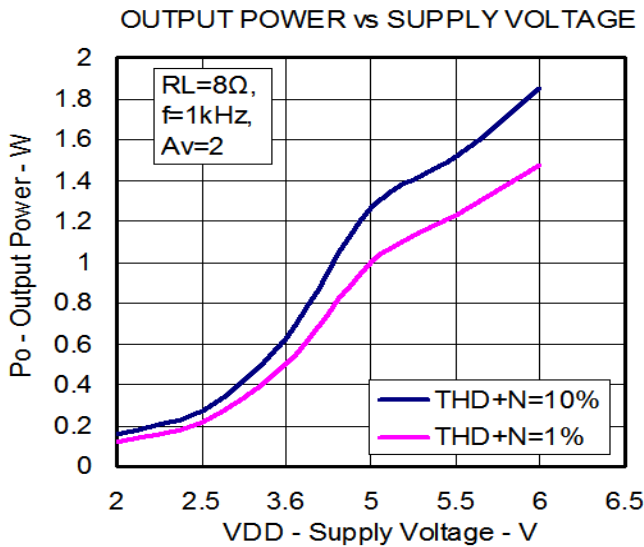

Figure 22
Noise Floor (VDD=3.6V / 8Ω)





APPLICATION INFORMATION

The LY8662's QFN package provides a low thermal resistance between the die and the PCB to which the part is mounted and soldered. This allows rapid heat transfer from the die to the surrounding PCB copper traces, ground plane and, finally, surrounding air. The result is a low voltage audio power amplifier that produces 2.0W at 10% THD with a 4Ω load from a 5.5V power supply. This high power is achieved through careful consideration of necessary thermal design. Failing to optimize thermal design may compromise the LY8662's high power performance and activate unwanted, though necessary, thermal shutdown protection.

POWER SUPPLY BYPASSING

As with any power amplifier, proper supply bypassing is critical for low noise performance and high power supply rejection. Applications that employ a 5V regulator typically use a 10 μF in parallel with a 0.1 μF filter capacitor to stabilize the regulator's output, reduce noise on the supply line, and improve the supply's transient response. However, their presence does not eliminate the need for a local 1.0 μF tantalum bypass capacitance connected between the LY8662's supply pins and ground. Do not substitute a ceramic capacitor for the tantalum. Doing so may cause oscillation. Keep the length of leads and traces that connect capacitors between the LY8662's power supply pin and ground as short as possible.

MICRO-POWER SHUTDOWN

The voltage applied to the SHUTDOWN pin controls the LY8662's shutdown function. Activate micro-power shutdown by applying GND to the SHUTDOWN pin. When active, the LY8662's micro-power shutdown feature turns off the amplifier's bias circuitry, reducing the supply current. The low 0.1 μA typical shutdown current is achieved by applying a voltage that is as near as GND as possible to the SHUTDOWN pin. A voltage that is more than GND may increase the shutdown current.

Table 1 shows the logic signal levels that activate and deactivate micro-power shutdown and headphone amplifier operation.

There are a few ways to control the micro-power shutdown. These include using a single-pole, single-throw switch, a microprocessor, or a microcontroller. When using a switch, connect an external 20k resistor between the SHUTDOWN pin and Ground. Connect the switch between the SHUTDOWN pin VDD. Select normal amplifier operation by closing the switch. Opening the switch sets the SHUTDOWN pin to ground through the 20k resistor, which activates the micro-power shutdown. The switch and resistor guarantee that the SHUTDOWN pin will not float. This prevents unwanted state changes. In a system with a microprocessor or a microcontroller, use a digital output to apply the control voltage to the SHUTDOWN pin. Driving the SHUTDOWN pin with active circuitry eliminates the pull up resistor.

TABLE 1. Logic Level Truth Table

Shutdown Pin	Headphone Jack Sense Pin	Operational Output Mode
Logic High	Low (HP not Plugged in)	BTL
Logic High	High (HP Plugged in)	Single-Ended
Logic Low	High or Low Don't care	Micro-Power Shutdown

HEADPHONE SENSE AND HEADPHONE LOGIC IN FUNCTIONS

Applying a logic level to the LY8662's HP Sense headphone control pin turns off Amp. A (+out) and Amp. B (+out) muting a bridged-connected load. Quiescent current consumption is reduced when the IC is in this single-ended mode.

Figure 2 shows the implementation of the LY8662's headphone control function. With no headphones connected to the headphone jack, the R5-R6 voltage divider sets the voltage applied to the HP Sense pin (pin 14) at approximately 50mV. This 50mV enables Amp A (+out) and Amp B (+out) placing the LY8662 in bridged mode operation.

While the LY8662 operates in bridged mode, the DC potential across the load is essentially 0V. Therefore, even in an ideal situation, the output swing cannot cause a false single-ended trigger. Connecting headphones to the headphone jack disconnects the headphone jack contact pin from -OUTA and allows R7 to pull the HP Sense pin up to VDD.

This enables the headphone function, turns off Amp A (+out) and Amp B (+out) which mutes the bridged speaker. The amplifier then drives the headphones, whose impedance is in parallel with resistors R5 and R6. These resistors have negligible effect on the LY8662's output drive capability since the typical impedance of headphones is 32Ω.

Figure 23 also shows the suggested headphone jack electrical connections. The jack is designed to mate with a four wire (or three wire) plug. The plug's tip and ring should each carry one of the two stereo output signals, whereas the sleeve should carry the ground return. The headphone jack with one control pin contact is sufficient to drive the HP Sense pin when connecting headphones.

As outlined above driving the Speaker (BTL) and Headphone (SE) loads simultaneously using LY8662 is simple and easy. However this configuration will only work if the HP Logic pin is used to control the BTL/SE operation and HP Sense pin is connected to GND(Figure 24).

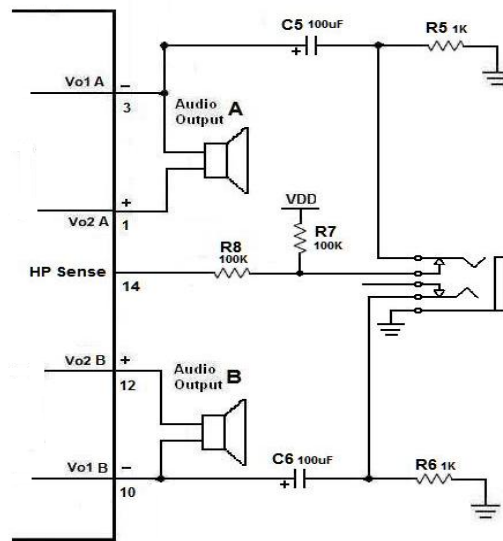
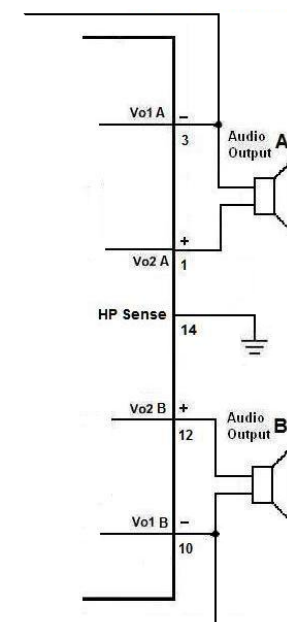
FIGURE 23. With Headphone Circuit (QFN Type)

FIGURE 24. Without Headphone Circuit (QFN Type)



Bypass Capacitor Value Selection

Besides minimizing the input capacitor size, careful consideration should be paid to value of C4, the capacitor connected to the BYPASS pin. Since C4 determines how fast the LY8662 settles to quiescent operation, its value is critical when minimizing turn-on pops. The slower the LY8662's outputs ramp to their quiescent DC voltage (nominally 1/2 VDD), the smaller the turn-on pop. Choosing C4 equal to 1.0 μ F along with a small value of C2,C3 (in the range of 0.1 μ F to 0.39 μ F), produces a click-less and pop-less shutdown function. As discussed above, choosing C1 no larger than necessary for the desired bandwidth helps minimize clicks and pops. Connecting a 1 μ F capacitor, C4, between the BYPASS pin and ground improves the internal bias voltage's stability and improves the amplifier's PSRR.

OPTIMIZING CLICK AND POP REDUCTION PERFORMANCE

The LY8662 contains circuitry that minimizes turn-on and shutdown transients or "clicks and pop". For this discussion, turn-on refers to either applying the power supply voltage or when the shutdown mode is deactivated. When the part is turned on, an internal current source changes the voltage of the BYPASS pin in a controlled, linear manner. Ideally, the input and outputs track the voltage applied to the BYPASS pin. The gain of the internal amplifiers remains unity until the voltage on the bypass pin reaches 1/2 VDD. As soon as the voltage on the bypass pin is stable, the device becomes fully operational. Although the BYPASS pin current cannot be modified, changing the size of C4 alters the device's turn-on time and the magnitude of "clicks and pops". Increasing the value of C4 reduces the magnitude of turn-on pops. However, this presents a tradeoff: as the size of C4 increases, the turn-on time increases. There is a linear relationship between the size of C4 and the turn-on time. Here are some typical turn-on times for various values of C4:

In order eliminate "clicks and pops", all capacitors must be discharged before turn-on. Rapidly switching VDD on and off may not allow the capacitors to fully discharge, which may cause "clicks and pops".

TABLE 2. C4 and TON Truth Table

C4	T _{ON} (Typ.) at 5.0V
1.0 μ F	172 ms
0.47 μ F	76 ms
0.33 μ F	60 ms
0.22 μ F	50 ms
0.1 μ F	36 ms



PACKAGE OUTLINE DIMENSION

16-Pin 3X3 QFN Package Outline Dimension

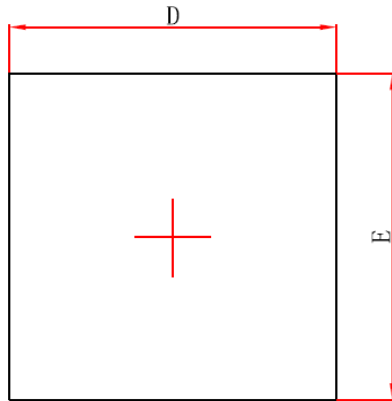

Top View

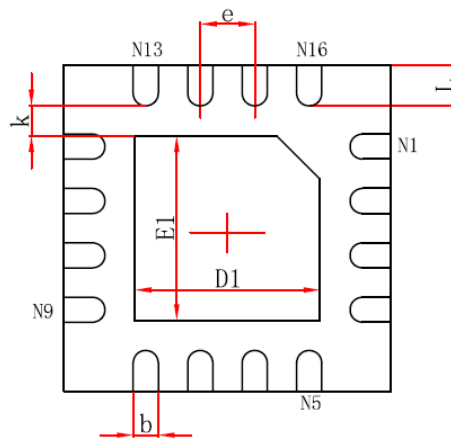

Bottom View

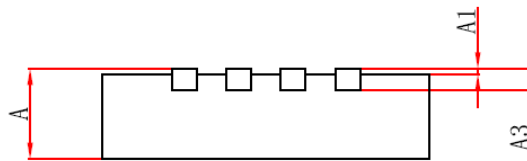

Side View

Symbol	Dimensions In Millimeters	
	Min.	Max.
A	0.700	0.800
A1	0.000	0.050
A3	0.203REF.	
D	2.900	3.100
E	2.900	3.100
D1	1.600	1.800
E1	1.600	1.800
k	0.200MIN.	
b	0.180	0.300
e	0.500TYP.	
L	0.300	0.500